





DESCRIZIONE

Macchina polifunzionale compatta e versatile per diversi utilizzi in tutte le stagioni. Omologazione Europea 'Mother Regulation' per circolazione su strada; omologata in Italia come macchina agricola o operatrice.

Brevetti: cabina, filtro aspirazione e bocca di aspirazione.
Accessori facilmente intercambiabili tra di loro.
Macchina ideale per enti pubblici, manutentori spazi verdi e pulizia.

DESCRIPTION

Multi-purpose machine compact and adaptable for different uses in all seasons. European Homologation 'Mother Regulation' for road circulation.

Patents: cabin, suction filter and suction mouth.
Easily interchangeable accessories.
Ideal machine for municipalities and professional landscaping.



DIMENSIONI / DIMENSIONS

Lunghezza / Length	2755 mm
Larghezza / Width	1030 mm
Altezza al punto massimo / Height at the max point	2255 mm
Raggio di sterzata / Turning radius	682 mm

MOTORE / ENGINE

Costruttore / Manufacturer	Kubota
Modello / Type	WG1605 stage V ET04
Cilindrata / Displacement	1537 cc
Potenza / Output	30.3kW a 2650 rpm
Coppia / Torque	112Nm a 2650 rpm
Velocità / Speed	0-25km/h
Capacità serbatoio / Fuel tank	25 l
Carburante / Fuel	benzina/ gasoline

TRASMISSIONE / VEHICLE DRIVE

Sistema di trasmissione / Drive system	Idrostatico / Hydrostatic
Asse guida / Drive axle	Snodato / Articulated
Pendenza superabile / Gradeability up to	25%

HOPPER / TRAMOGGIA

Volume tramoggia / Hopper Volume	0,7 m ³
Altezza scarico tramoggia / Discharge height	1400 mm

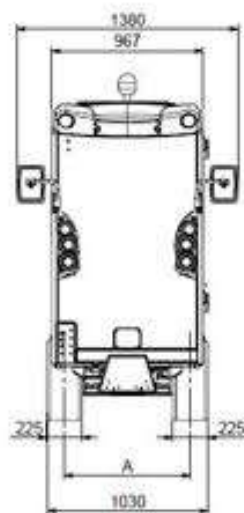
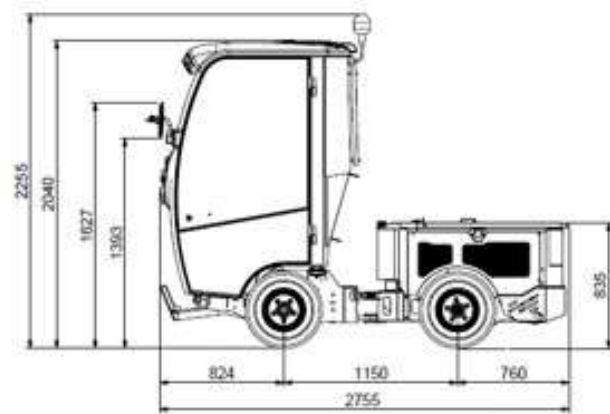

**MACCHINA MULTIACCESSORIO MPM
C/CABINA MOTORE KUBOTA WG1605
C/RISCALDAMENTO E ARIA CONDIZIONATA
MULTI PURPOSE MACHINE MPM WITH CABIN,
KUBOTA ENGINE, WITH HEATER AND
AIR CONDITIONING**

Macchina completa di ruote, cabina (ROPS structure), sedile ammortizzato, riscaldamento, aria condizionata, fanali, fanali anteriori lavoro a led, radio, colonna volante regolabile, specchietti retrovisori. Machine complete with wheels, cabin (ROPS structure) suspension seat, heating, lights, LED front works lights, radio, adjustable steering coloum, rearview mirrors.

COLORI: Bianco/Rosso
COLORI: White/Red





La cabina è stata progettata per essere confortevole e garantire massima visibilità esterna.

The cabin has been designed and patented to be comfortable and to ensure maximum external visibility.



Sedile e Colonna del volante regolabili.

Seat and steering wheel column adjustable.



Rumorosità ridotta a 80 DB.

Noise reduced to 80 DB.





Bocca di aspirazione brevettata
Patented Suction mouth

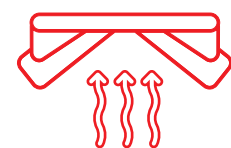

Bocca di aspirazione flessibile fino a 10 cm per superare gli ostacoli, garantendo alla macchina di lavorare agilmente in ogni condizione. Dispositivo interamente progettato e brevettato da Fort.

Suction mouth flexible up to 10 cm to overcome obstacles, ensuring the machine to work easily in all conditions. Device entirely designed and patented by Fort.

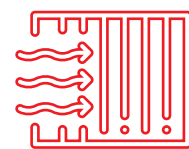

Filtro Brevettato
Patented Filter

Filtro facilmente removibile e lavabile.
Easily removable and washable filter.



SISTEMA SPAZZOLE / SWEEPING SYSTEM

Spazzola / Brush	Ø 600 mm
Velocità spazzola / Brush speed	63,5 RPM/min
Larghezza massima di lavoro con 2 spazzole / Max sweeping path with 2 brushes	160 cm

SISTEMA ASPIRAZIONE / SUCTION SYSTEM

Larghezza bocca aspirazione / Suction nozzle width	464 mm
Ampiezza foro / Wander hose	Ø 160 mm

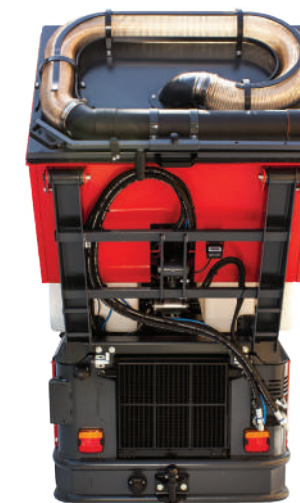

GR. LAMA CM. 130
SNOW SHIELD 130 CM.

SPAZZOLONE CM.120 D.50
SWEEPER 120 CM. D.50



PULIZIA NEVE / SNOW REMOVAL



PULIZIA / CLEANING

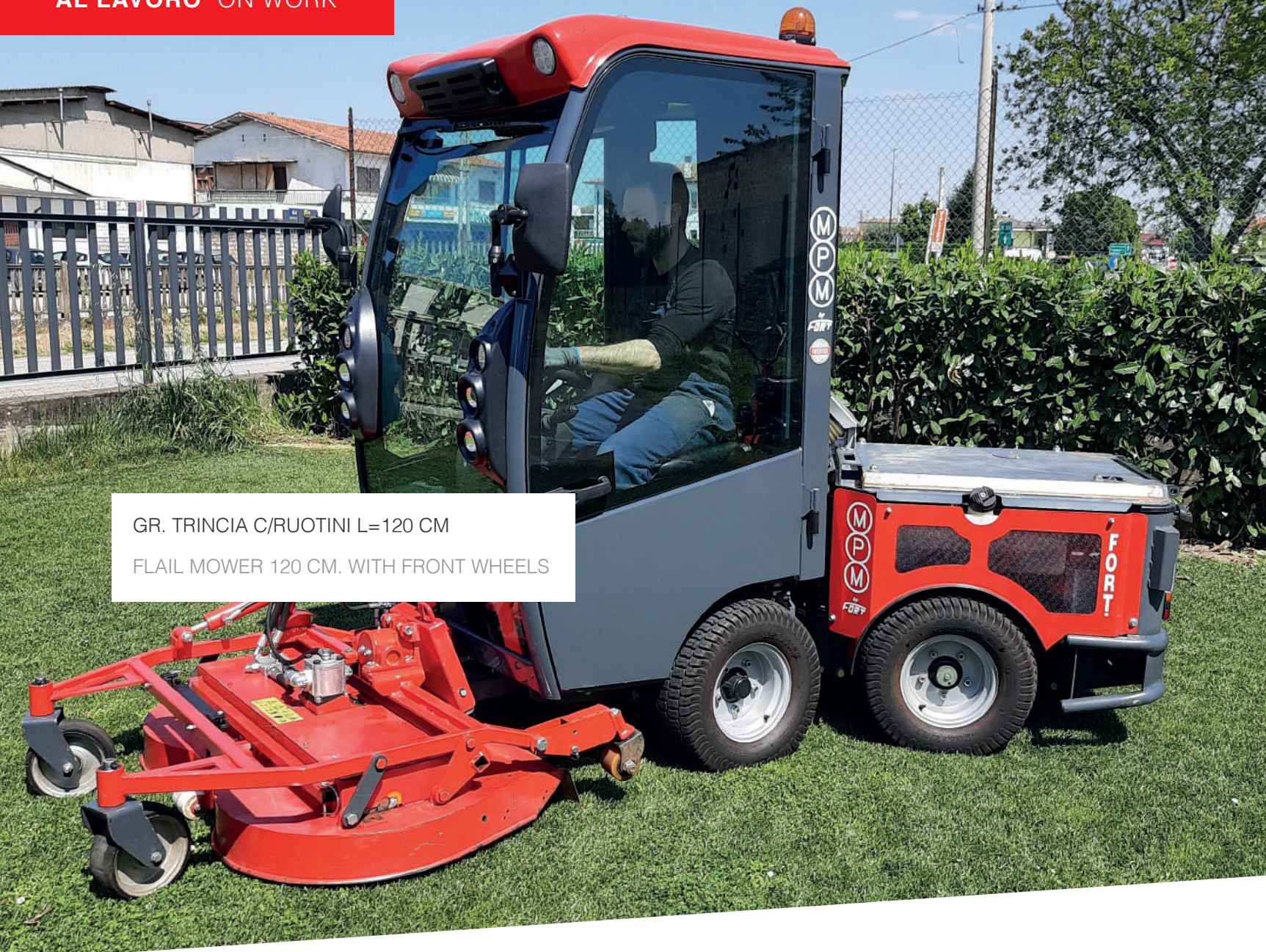

GR. TRINCIA C/RUOTINI L=120 CM
FLAIL MOWER 120 CM. WITH FRONT WHEELS



SPAZZOLA DI ACCIAIO / WEEDBRUSH
GR. PIATTO 2 LAME CM. 125 S/CENTRALE
MOWING DECK 125 CM. REAR DISCHARGE



GIARDINAGGIO / GARDENING

I differenti accessori ad innesto rapido sono applicabili facilmente da un unico operatore.
The different quick coupling accessories are easily applicable by a single operator.



RUOTA CENTRALE PER SPAZZOLE D.235X65
FRONT WHEEL FOR BRUSHES D.235X65

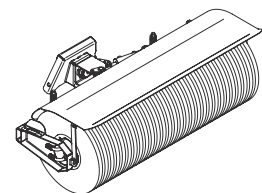

SPAZZOLONE NEVE CM.120 D.50
NOW SWEEPER 120 CM. D.50

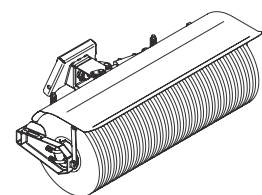

SPAZZOLONE CM.120 D.50
SWEEPER 120 CM. D.50

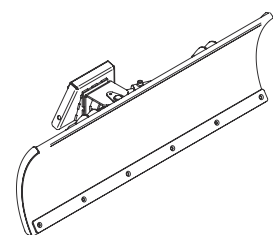

GR. LAMA CM. 130
SNOW SHIELD 130 CM

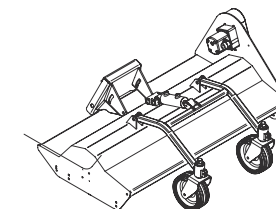

GR. TRINCIA C/RUOTINI L=120 CM
FLAIL MOWER 120 CM. WITH FRONT WHEELS

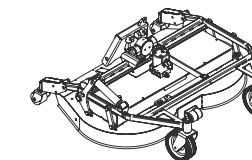

GR. PIATTO 2 LAME CM. 125 S/CENTRALE
MOWING DECK 125 CM. REAR DISCHARGE

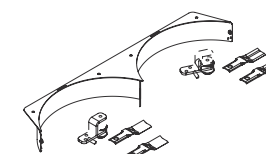

KIT MULCHING PER PIATTO 125 CM
MULCHING KIT FOR MOWING DECK 125 CM



KIT TELECAMERA POSTERIORE SCHERMO 5"
KIT REAR VIEW CAMERA, SCREEN 5"

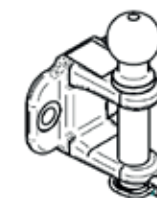

GANCIO DI TRAINO OMOLOGATO CON
CONNETTORE LUCI
HOMOLOG. HITCH BALL INCLUD
CONNECTOR LIGHTS



KIT AUTORADIO CD-USB C/TELECOMANDO
RADIO-CD-USB KIT, W/REMOTE CONTROL



FORT S.R.L. UNIPERSONALE | VIA SECCALEGNO, 29 - 36040 SOSSANO (VI) ITALY
www.fort-it.com +39 044 4788000 +39 044 4788020 info@fort-it.com